

Go to www.vtechphones.com to register your product for enhanced warranty support and the latest VTech product news.

CS6719
CS6719-15
CS6719-16
CS6719-2
DECT 6.0 cordless telephone



vtech

Abridged user's manual

Congratulations

on purchasing your new VTech product. Before using this product, please read **important safety instructions**.

This abridged user's manual provides you with basic installation and use instructions. A limited set of features are described in abbreviated form.

Please refer to the online User's manual for a full set of installation and operation instructions at www.vtechphones.com.



Telephones identified with this logo have reduced noise and interference when used with most T-coil equipped hearing aids and cochlear implants. The TIA-1083 Compliant Logo is a trademark of the Telecommunications Industry Association. Used under license.

What's in the box

Your product package contains the following items. Save your sales receipt and original packaging in the event warranty service is necessary.

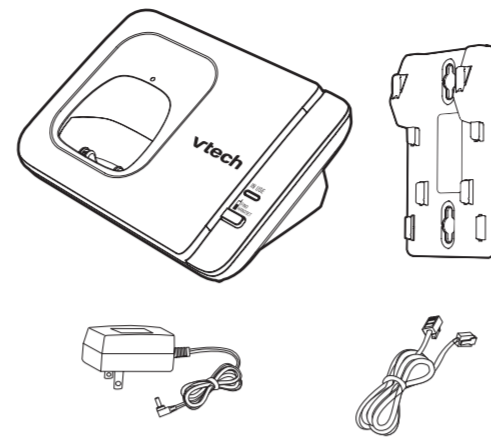

1 set for CS6719/
CS6719-15/
CS6719-16;
2 sets for CS6719-2

1 set for CS6719-2

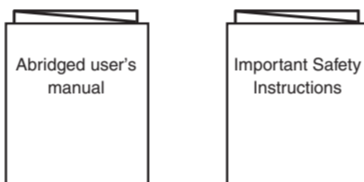

Handset overview

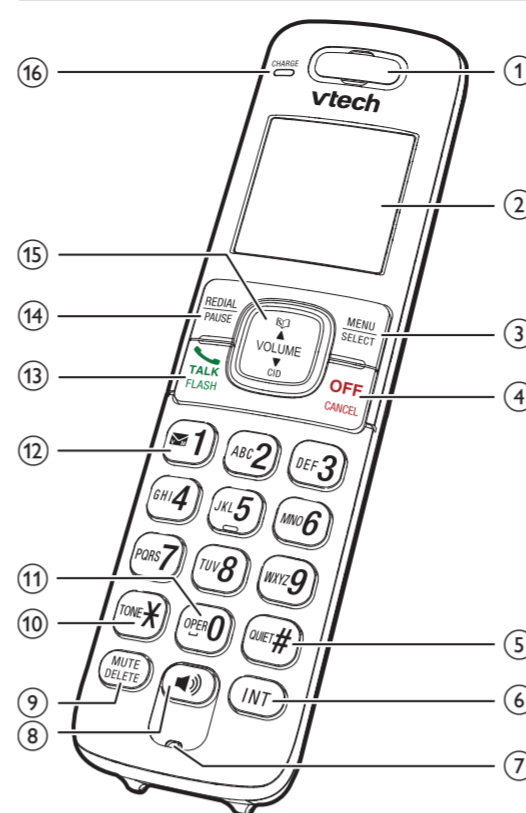

- Handset earpiece**
- LCD display**
- MENU/SELECT**
 - Show the menu.
 - While in a menu, press to select an item, or save an entry or setting.
- OFF/CANCEL**
 - Hang up a call.
 - Silence the ringer temporarily while the handset is ringing.
 - Press and hold to erase the missed call indicator while the phone is not in use.
 - Press to return to the previous menu; or press and hold to return to idle mode, without making changes.
- OPER #**
 - Press repeatedly to show other dialing options when reviewing a caller ID log entry.
- INT**
 - Press to start an intercom conversation or transfer a call (for multi-handset models only).

7 - Microphone

- Make or answer a call using the handset speakerphone.
 - During a call, press to switch between the speakerphone and the handset.

9 - MUTE/DELETE

- Mute the microphone during a call.
- Delete digits or characters while using the dialing keys.
- Silence the ringer temporarily while the handset is ringing.

10 - TONE X

- While you have set the dial mode to pulse and on a call, press to switch to tone dialing temporarily.

11 - OPER 0

- Press to add a space when entering names.

12 - 1

- Press repeatedly to add or remove 1 in front of the caller ID log entry before dialing or saving it to the directory.
- Press and hold to set or dial your voicemail number.

13 - TALK /FLASH

- Make or answer a home call.
- Answer an incoming home call when you hear a call waiting alert.

14 - REDIAL/PAUSE

- Press repeatedly to review the redial list.
- Press and hold to insert a dialing pause while entering a number.

15 - VOLUME/▲/▼

- Review the directory when the phone is not in use.
- Increase the listening volume during a call.
- Scroll up while in a menu, or in the directory, caller ID log, or redial list.
- Move the cursor to the right when entering numbers or names.

VOLUME/▼/CID

- Review the caller ID log when the phone is not in use.
- Decrease the listening volume during a call.
- Scroll down while in a menu, or in the directory, caller ID log, or redial list.
- Move the cursor to the left when entering numbers or names.

16 - CHARGE light

- On when the handset is charging.

Telephone base overview

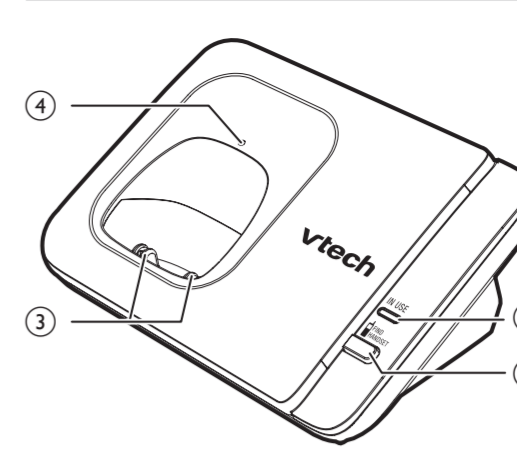

1 - IN USE light

- Flashes when there is an incoming call, or another telephone sharing the same line is in use.
- On when the handset is in use.

2 - FIND HANDSET

- Press to page all system handsets.

3 - Charging pole

4 - Charge light

Charger overview

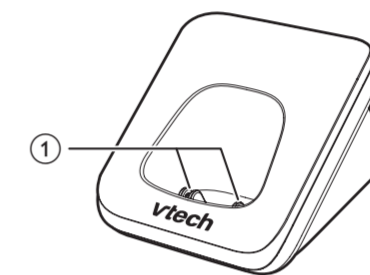

1 - Charging pole

Display icons overview

	The battery icon flashes when the battery is low and needs charging.
	The battery icon animates when the battery is charging.
	The battery icon becomes solid when the battery is fully charged.
	The handset ringer is off.
	There are new voicemail received from your telephone service provider.
ECO	The ECO mode activates automatically to reduce power consumption when the handset is within range from the telephone base.
NEW	There are new caller ID log entries.

Connect

You can choose to connect the telephone base for desktop usage or wall mounting.

NOTE

- Use only the power adapters supplied with this product.

TIP

- If you subscribe to digital subscriber line (DSL) high-speed Internet service through your telephone line, make sure you install a **DSL filter** (not included) between the telephone line cord and telephone wall jack. Contact your DSL service provider for more information.

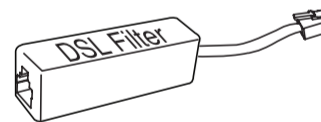

Connect the telephone base

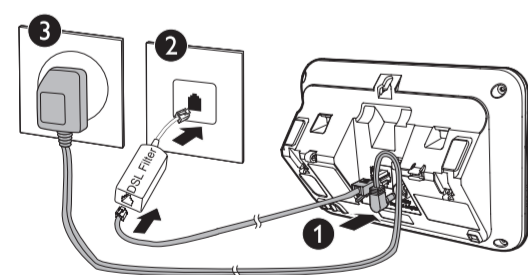

Connect the charger

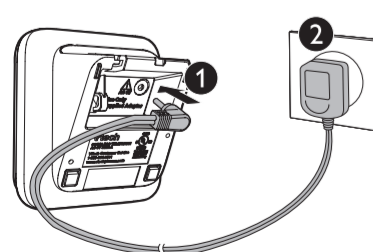

Mount the telephone base

The telephone comes ready for tabletop use. If you have already installed the telephone for tabletop use, unplug the telephone line cord from the telephone wall jack, and unplug the telephone base power adapter from the wall outlet before mounting your telephone on a wall. Follow the steps below to mount your telephone on a wall.

- Route the telephone line cord through the rectangular hole on the wall mount bracket. Then plug the two ends of the telephone line cord into the telephone base and the wall outlet as shown.

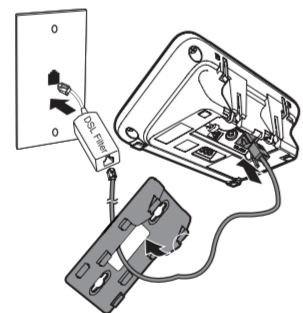

- Align the holes on the bracket with the standard wall plate and slide the bracket down until it clicks securely in place.

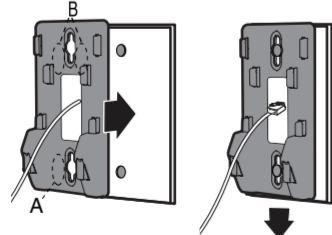

- Align the grooves on the telephone base with the tabs on the wall mount bracket, and then slide it down until it clicks securely in place.

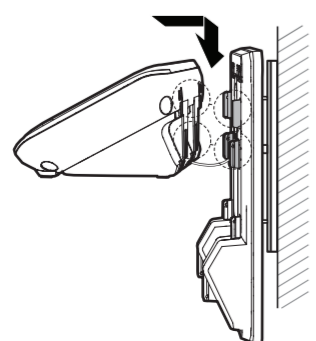

- Connect the power adapter to the telephone base and an electrical outlet not controlled by a wall switch.

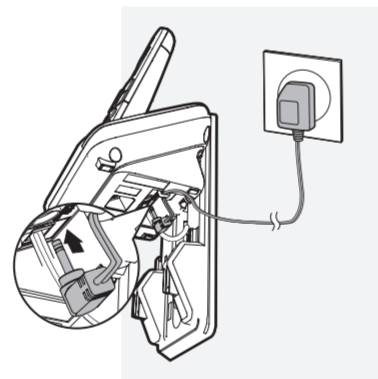

Install and charge the battery

Install the battery

Install the battery as shown below.

NOTES

- Use only supplied battery.
- If the handset will not be used for a long time, disconnect and remove the battery to prevent possible leakage.

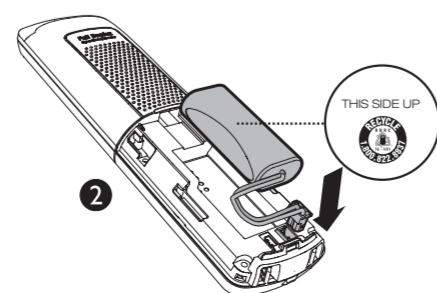
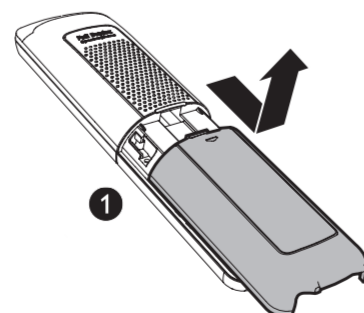

Charge the battery

Place the handset in the telephone base or the charger to charge.



Once you have installed the battery, the handset LCD display indicates the battery status (see the table below).

NOTES

- For best performance, keep the handset in the telephone base or charger when not in use.
- The battery is fully charged after 12 hours of continuous charging.

Battery indicators	Battery status	Action
The screen is blank, or shows Put in charger and flashes.	The battery has no charge or very little charge. The handset cannot be used.	Charge without interruption (at least 30 minutes).
The screen shows Low battery and flashes.	The battery has enough charge to be used for a short time.	Charge without interruption (at least 30 minutes).
The screen shows HANDSET X .	The battery is charged.	To keep the battery charged, place it in the telephone base or charger when not in use.

Before use

After you install your telephone or power returns following a power outage, the handset or telephone will prompt you to set the date and time.

Set date and time

- Use the dialing keys (0-9) to enter the month (MM), date (DD) and year (YY). Then press **SELECT**.
- Use the dialing keys (0-9) to enter the hour (HH) and minute (MM). Then press **▼** or **▲** to choose **AM** or **PM**.
- Press **SELECT** to save.

Check for dial tone:

Press **TALK**. If you hear a dial tone, the installation is successful.

If you do not hear a dial tone:

- Make sure the installation procedures described above are properly done.
- It may be a wiring problem. If you have changed your telephone service to digital service from a cable company or a VoIP service provider, the telephone line may need to be rewired to allow all existing telephone jacks to work. Contact your cable/VoIP service provider for more information.

Operating range

This cordless telephone operates with the maximum power allowed by the Federal Communications Commission (FCC). Even so, this handset and telephone base can communicate over only a certain distance - which can vary with the locations of the telephone base and handset, the weather, and the layout of your home or office.

When the handset is out of range, the handset displays **Out of range or no pwr at base**.

If there is a call while the handset is out of range, it may not ring, or if it does ring, the call may not connect well when you press **TALK**. Move closer to the telephone base, and then press **TALK** to answer the call. If the handset moves out of range during a telephone conversation, there may be interference. To improve reception, move closer to the telephone base.

Using the handset menu

- Press **MENU** when the phone is not in use.
- Press **▼** or **▲** until the screen displays the desired feature menu.
- Press **SELECT** to enter that menu.
- To return to the previous menu, press **CANCEL**.
- To return to idle mode, press and hold **CANCEL**.

Configure your telephone

Set language

The LCD language is preset to English. You can select English, French or Spanish to be used in all screen displays.

- Press **MENU** when the handset is not in use.
- Scroll to **Settings**, and then press **SELECT** twice.
- Scroll to choose **English**, **Français** or **Español**, and then press **SELECT**.
- Press **SELECT** again to save.

Set date and time

- Press **MENU** when the handset is not in use.
- Scroll to **Set date/time**, and then press **SELECT**.
- Use the dialing keys (0-9) to enter the month (MM), date (DD) and year (YY). Then press **SELECT**.
- Use the dialing keys (0-9) to enter the hour (HH) and minute (MM). Then press **▼** or **▲** to choose **AM** or **PM**.
- Press **SELECT** to save.

Temporary tone dialing

If you have pulse (rotary) service only, you can switch from pulse to tone dialing temporarily during a call.

- During a call, press **TONE X**.
- Use the dialing keys to enter the relevant number. The telephone sends touch-tone signals. It automatically returns to pulse dialing mode after you end the call.

Telephone operation

Handset control key panel:

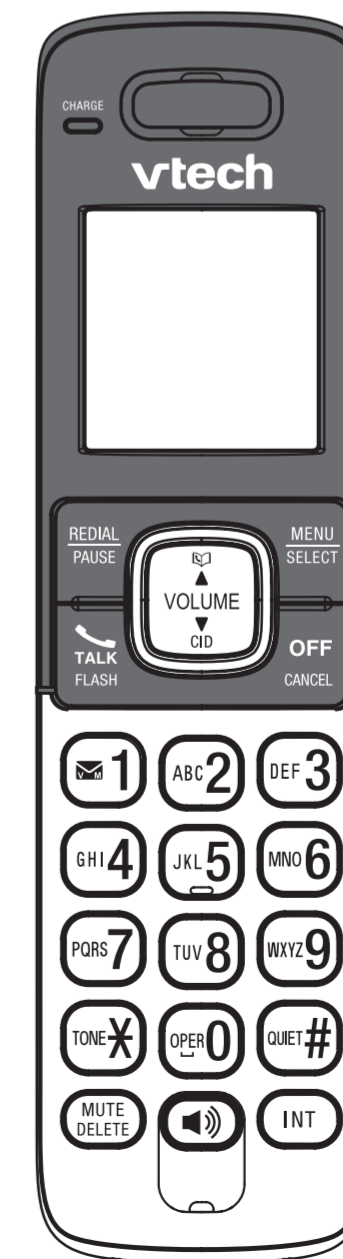

Make a call

- Press **TALK** or **FLASH**, and then dial the telephone number.

Answer a call

- Press **TALK**, **FLASH**, or any dialing key.

End a call

- Press **OFF** on the handset, or put the handset to the base or charger.

Speakerphone

- During a call, press **FLASH** on the handset to switch between speakerphone and normal handset use.

Volume

- During a call, press **▼/VOLUME/▲** on the handset to adjust the listening volume.

NOTE

The handset earpiece volume setting and speakerphone volume setting are independent.

Mute

The mute function allows you to hear the other party but the other party cannot hear you.

- During a call, press **MUTE** on the handset or telephone base. The screen displays **Muted**.
- Press **MUTE** again to resume the conversation. The screen displays **Microphone ON**.

Call waiting

When you subscribe to call waiting service from your telephone service provider, you hear an alert tone if there is an incoming call while you are on another call.

- Press **FLASH** to put the current call on hold and take the new call.
- Press **FLASH** to switch back and forth between calls.

Find handset

Use this feature to find all system handsets.

To start paging:

- Press **FIND HANDSET** on the telephone base. All idle handsets ring and display **** Paging ****.

To end paging:

- Press **FIND HANDSET** again on the telephone base.

